

Digital temperature transmitters

Model T12.10, universally programmable, head mounting version

Model T12.30, universally programmable, rail mounting version

WIKA data sheet TE 12.03



Applications

- Process industry
- Machinery and plant construction

Special features

- Universal configuration via Windows PC, simulation of the sensor not necessary
- Isolation voltage AC 1500 V between sensor and current loop
- Signalling configurable for sensor burnout and sensor short circuiting
- 100 % rel. humidity protection, moisture condensation permissible



Fig. left: digital temperature transmitter model T12.10
Fig. right: digital temperature transmitter model T12.30

Description

These temperature transmitters are designed for universal use in the process industry. They offer a high accuracy, galvanic isolation and an excellent EMI protection.

In addition to the different sensor types e.g. sensors in accordance with DIN EN 60751, JIS C1606, DIN 43760, DIN EN 60584 or DIN 43710, customer specific sensor-curves can also be defined, through the input of value pairs.

The sensor connection arrangement is configurable, thus ensuring optimal lead wire compensation. Cold junction compensation for thermocouples is built-in, while external cold junction compensation can also be selected.

The configurable error signalling (e.g. sensor burnout, hardware errors, sensor over/under-range) ensures a high degree of monitoring flexibility.

Configuration changes can be quickly and easily transmitted to the T12 using the WIKA_T12 configuration software (free download at www.wika.de) and the communication interface (programming unit), which is available as an accessory. Its two-way communication enables the measured values to be displayed on a PC/notebook.

The programming unit provides voltage to the T12 transmitter, so that no additional supply is required to configure the T12.

The dimensions of the head-mounted transmitter match the Form-B DIN connecting heads with extended mounting space, e.g. WIKA model BSS.

The rail-mounted transmitters can be used for all standard rack systems in accordance with IEC 60715.

The transmitters are delivered with either a basic configuration or configured according to customers' specifications.

Specifications of models T12.10 head mounting version and T12.30 rail mounting version

Temperature Transmitter Input; configurable

Resistance sensor	Configurable measuring range ¹⁾	Standard	α values	Minimum measuring span	Typical accuracy at 23 °C 5 K	
					Basic accuracy	Temperature coefficient
Pt100	-200 ... +850 °C	IEC 60751: 1996	$\alpha = 0.00385$	25 K	$\leq \pm 0.2$ °C ³⁾	$\leq \pm 0.026$ °C / °C ⁴⁾
Pt1000	-200 ... +850 °C	IEC 60751: 1996	$\alpha = 0.00385$		$\leq \pm 0.2$ °C ³⁾	$\leq \pm 0.026$ °C / °C ⁴⁾
JPt100	-200 ... +500 °C	JIS C1606: 1989	$\alpha = 0.003916$		$\leq \pm 0.2$ °C ³⁾	$\leq \pm 0.026$ °C / °C ⁴⁾
Ni100	-60 ... +250 °C	DIN 43760: 1987	$\alpha = 0.00618$		$\leq \pm 0.2$ °C ³⁾	$\leq \pm 0.026$ °C / °C ⁴⁾
Resistance sensor	0 ... 5 k Ω			30 Ω	$\leq \pm 0.07$ Ω ⁵⁾	$\leq \pm 0.026$ Ω / °C ⁵⁾
Sensor current			max. 0.2 mA (Pt100)			
Connection type			1 sensor 2- /4- /3-wire (for further information, please refer to Designation of Terminal Connection)			
Max. wire resistance			30 Ω each wire, 3-wire symmetrically			
Thermocouple	Configurable measuring range ¹⁾	Standard	Minimum measuring span		Typical accuracy at 23 °C 5 K	
					Basic accuracy	Temperature coefficient
Type J (Fe-CuNi)	-100 ... +1200 °C	IEC 584: 1998-06	50 K or 2 mV whichever is greater		$\leq \pm 0.5$ °C ⁶⁾	$\leq \pm 0.05$ °C / °C ⁶⁾
Type K (NiCr-Ni)	-180 ... +1372 °C	IEC 584: 1998-06			$\leq \pm 0.5$ °C ⁶⁾	$\leq \pm 0.05$ °C / °C ⁶⁾
Type L (Fe-CuNi)	-100 ... +900 °C	DIN 43760: 1985-12			$\leq \pm 0.5$ °C ⁶⁾	$\leq \pm 0.05$ °C / °C ⁶⁾
Type E (NiCr-Cu)	-100 ... +1000 °C	IEC 584: 1998-06			$\leq \pm 0.5$ °C ⁶⁾	$\leq \pm 0.05$ °C / °C ⁶⁾
Type T (Cu-CuNi)	-200 ... +400 °C	IEC 584: 1998-06			$\leq \pm 0.5$ °C ⁶⁾	$\leq \pm 0.05$ °C / °C ⁶⁾
Type N (NiCrSi-NiSi)	-180 ... +1300 °C	IEC 584: 1998-06	100 K		$\leq \pm 0.5$ °C ⁶⁾	$\leq \pm 0.05$ °C / °C ⁶⁾
Type U (Cu-CuNi)	-200 ... +600 °C	DIN 43710: 1985-12	75 K		$\leq \pm 0.5$ °C ⁶⁾	$\leq \pm 0.05$ °C / °C ⁶⁾
Type R (PtRh-Pt)	-50 ... +1768 °C	IEC 584: 1998-06	200 K		$\leq \pm 0.5$ °C ⁶⁾	$\leq \pm 0.2$ °C / °C ⁶⁾
Type S (PtRh-Pt)	-50 ... +1768 °C	IEC 584: 1998-06	200 K		$\leq \pm 0.5$ °C ⁷⁾	$\leq \pm 0.2$ °C / °C ⁶⁾
Type B (PtRh-Pt)	0 ... +1820 °C ²⁾	IEC 584: 1998-06	200 K		$\leq \pm 0.5$ °C ⁷⁾	$\leq \pm 0.2$ °C / °C ⁷⁾
Type W3, W3Re/W25Re	0 ... +2300 °C	ASTM E988	200 K		$\leq \pm 0.5$ °C ⁷⁾	$\leq \pm 0.2$ °C / °C ⁷⁾
Type W5, W5Re/W26Re	0 ... +2300 °C	ASTM E988	200 K		$\leq \pm 0.5$ °C ⁷⁾	$\leq \pm 0.2$ °C / °C ⁷⁾
mV-Sensor	-10 ... +800 mV		4 mV		$\leq \pm 0.2$ mV ⁸⁾	$\leq \pm 0.022$ mV / °C ⁸⁾
Connection type			1 sensor (for further information, please refer to Designation of Terminal Connection)			
Max. wire resistance			250 Ω			
Cold junction compensation, configurable			compensation; internal or external with Pt100 or with thermostat or off			

1) Other units e.g. °F and K on request

2) Technical data valid only for configured measuring range ≥ 400 °C

3) Based on 3-wire Pt100, Ni100, 150 °C FS

4) Based on 150 °C FS, at ambient temperature range -40 ... +85 °C

5) Based on R_{total} 1 k Ω (3-wire)

6) Based on 400 °C FS at ambient temperature range

-40 ... +85 °C for T12.10 or

-20 ... +70 °C for T12.30

7) Based on 1000 °C FS at ambient temperature range

-40 ... +85 °C for T12.10 or

-20 ... +70 °C for T12.30

8) Based on 400 mV FS at ambient temperature range

-40 ... +85 °C for T12.10 or

-20 ... +70 °C for T12.30

bold: basic configuration

FS = Full scale of configured measuring range

User linerisation

Via software, customer-specific sensor curves can be stored in the transmitter, so that further sensor types can be used.

Number of data points: min. 2; max. 30

Analogue output / output limits / signalling / isolation resistance

Analogue output, configurable	linear to temperature per IEC 60751 / JIS C1606 / DIN 43760 (for resistance sensors) or linear to temperature per IEC 60584 / DIN 43710 (for thermocouples)	
	4 ... 20 mA or 20 ... 4 mA, 2-wire design	
Output limits, configurable	lower limit	upper limit
to NAMUR NE 43	3.8 mA	20.5 mA
not active	3.6 mA	23 mA
customer specific, adjustable	from 3.6 mA up to 4,0 mA	from 20.0 mA up to 23 mA
Current value for signalling, configurable	down scale	up scale
to NAMUR NE 43	< 3.6 mA (3.5 mA)	> 21.0 mA (21.5 mA)
default value	from 3.5 mA up to 12 mA	from 12 mA up to 23 mA
In simulation mode, independent from input signal, simulation value configurable from 3.5 mA to 23 mA		
Load R_A	$R_A \leq (U_B - 9 V) / 0.023 A$ with R_A in Ω and U_B in V	
Isolation voltage (input to analogue output)	AC 1500 V, (50 Hz / 60 Hz); 60 s	
Power consumption with $U_B = 24 V$	max. 552 mW	

Rise time / damping / measuring rate

Rise time t_{90}	approx. 0.5 s
Damping , configurable	off ; configurable between 0.5 s up to 60 s possible
Turn on time (time to get the first measured value)	5 s
Measuring rate	Measured value update approx. 2/s

bold: basic configuration

Measuring deviation / temperature coefficient

Load effect	± 0.01 % of span / 100 Ω
Power supply effect	± 0.005 % of span / V
Warm-up time	after approx. 5 minutes the instrument will function to the specified technical data (accuracy)

Input	Measuring deviation ¹⁾ per DIN EN 60770, 23 °C ± 5 K	Temperature coefficient ²⁾ from -40 ... +85 °C	Connection lead effects
Resistance thermometer (Pt100)	± 0.2 K or $\pm (0.025$ % FS + 0.1) K	$\pm (0.025$ % FS + 0.09) K / 10 K	4-wire: no effect (0 to 30 Ω each wire)
Resistance sensor	± 0.07 Ω or ± 0.03 % FS in Ω	$\pm (0.025$ % FS + 0.01) Ω / 10 K	3-wire: ± 0.02 Ω / 10 Ω (0 to 30 Ω each wire) 2-wire: connection lead effects ⁴⁾
Thermocouples type T, E, J, L, K, N, U ³⁾	± 0.5 K or ± 0.05 % FS or ± 10 μ V	$\pm (0.05$ % FS + 0.1) K / 10 K or ± 0.5 K / 10 K	
type R, S, B, W3, W5 ³⁾	± 0.5 K or ± 0.05 % FS or ± 10 μ V	± 2 K / 10 K	0.5 μ V / 10 Ω ⁵⁾
mV-sensor	± 10 μ V or ± 0.05 % FS in mV	$\pm (0.05$ % FS + 0.02) mV / 10 K	0.1 μ V / 10 Ω ⁵⁾
Cold Junction Compensation (CJC)	± 1.0 K	± 0.2 K / 10 K	
Output	± 0.05 % of span	± 0.1 % of span / 10 K	

Total measuring deviation: su of input + output per DIN EN 60770, 23 °C ± 5 K

FS Full scale value of configured measuring range

1) The higher value applies

2) With extended ambient temperature range (-50 ... +85 °C) the double value applies

3) Valid only for configured lower limit of range ≥ -150 °C

4) Manually compensation possible

5) Within the range to 250 Ω wire resistance

Monitoring

Test current for sensor monitoring ⁶⁾	nom. 33 μ A during test cycle, otherwise 0 μ A
Sensor burnout monitoring	activated
Self monitoring	automatic performance of an initial test after connecting the power supply

6) Valid for thermocouple only.

Explosion protection / power supply

Model	Approvals	Permissible ambient or storage temperature	Safety-related maximum values for		Power supply U_B ¹⁾
			Sensor (connections 1 up to 4)	Current loop (connections ±)	
T12.10.000/ T12.30.000	without	{-50} -40 ... +85 °C -20 ... +70 °C	-	-	9 ... 36 V
T12.10.002/ T12.30.002	EC-type examination certificate: DMT98 ATEX E 008 X Zone 0, 1: II 1G EEx ia IIB/IIC T4/T5/T6 intrinsically safe per directive 94/9/EG (ATEX)	-40 ... +85 °C (T4) -40 ... +75 °C (T5) -40 ... +60 °C (T6) -20 ... +70 °C (T4) -20 ... +70 °C (T5) -20 ... +60 °C (T6)	$U_O = DC 11.5 V$ $I_O = 31 mA$ $P_O = 87 mW$ IIB: $C_O = 11 \mu F$ $L_O = 8.6 mH$ IIC: $C_O = 1.5 \mu F$ $L_O = 8.6 mH$	$U_i = DC 30 V$ $I_i = 100 mA$ $P_i = 705 mW$ $C_i = 25 nF$ $L_i = 0.65 mH$	9 ... 30 V
T12.10.006/ T12.30.006	CSA File No. LR 105000-7 Intrinsically safe: Cl. I / Div. 1, Group A,B,C,D	-40 ... +85 °C (T4) -40 ... +75 °C (T5) -40 ... +60 °C (T6) -20 ... +70 °C (T4) -20 ... +70 °C (T5) -20 ... +60 °C (T6)	$U_{oc} = DC 11.5 V$ $I_{sc} = 31 mA$ $P_{max} = 87 mW$ $C_a = 0.4 \mu F$ $L_o = 8.65 mH$	$U_{max} = DC 30 V$ $I_{max} = 100 mA$ $P_{max} = 705 mW$ $C_i = 25 nF$ $L_i = 0.65 mH$	9 ... 30 V
T12.10.008/ T12.30.008	FM approval: Installation Drawing No. 3184731 Intrinsically safe: Cl. I / Div. 1, Group A,B,C,D	-40 ... +85 °C (T4) -40 ... +75 °C (T5) -40 ... +60 °C (T6) -20 ... +70 °C (T4) -20 ... +70 °C (T5) -20 ... +60 °C (T6)	$U_{oc} = DC 11.5 V$ $I_{sc} = 31 mA$ $P_{max} = 87 mW$ $C_a = 1.5 \mu F$ $L_a = 8.65 mH$	$U_{max} = DC 30 V$ $I_{max} = 100 mA$ $P_{max} = 705 mW$ $C_i = 25 nF$ $L_i = 0.65 mH$	9 ... 30 V
T12.10.009/ T12.30.009	Zone 2: II 3G Ex nA IIC T4/T5/T6 II 3G Ex nL IIC T4/T5/T6 II 3G Ex ic IIC T4/T5/T6	-40 ... +85 °C (T4) -40 ... +75 °C (T5) -40 ... +60 °C (T6) -20 ... +70 °C (T4) -20 ... +70 °C (T5) -20 ... +60 °C (T6)	$U_O = DC 5 V$ $I_O = 0.25 mA$ $C_O = 1000 \mu F$ $L_O = 1000 mH$	$U_i = DC 36 V$ $P_i = 1 W$ $C_i = 25 nF$ $L_i = 0.65 mH$	9 ... 36 V

¹⁾ Power supply input protected against reverse polarity; Load $RA \leq (UB - 9 V) / 0.023 A$ with RA in Ω and UB in V
 {} Items in curved brackets are optional extras for additional price, not for rail mounting T12.30

Ambient conditions

Climate class DIN EN 60654-1	T12.10: Cx (-40 ... +85 °C, 5 % up to 95 % relative air humidity) T12.30: Bx (-20 ... +70 °C, 5 % up to 95 % relative air humidity)
Maximum permissible humidity	T12.10: 100 % relative humidity (unlimited with isolated sensor connection wires) moisture condensation permissible DIN IEC 68-2-30 Var. 2 T12.30: 90 % relative humidity (DIN IEC 68-2-30 Var. 2)
Vibration	10 ... 2000 Hz 5 g DIN IEC 68-2-6
Shock	DIN IEC 68-2-27 30 g
Salt mist	DIN IEC 68-2-11
EMC directive	2004/108/EG, DIN EN 61326 emission (Group 1, Class B) and immunity (industrial locations), as well as NAMUR NE21

Case

Transmitter model	Material	Weight	Ingress protection ²⁾	Terminal connections (screws captive)
T12.10 head mounting version	Plastic PBT, glass-fibre reinforced	0,07 kg	IP 00 electronics completely potted	Wire cross-section max. 1.5 mm ²
T12.30 rail mounting version	Plastic	0,2 kg	IP 20	Wire cross-section max. 2.5 mm ²

²⁾ Ingress protection per IEC 60529 / EN 60529

Load diagram

The permissible load is dependent upon the loop power supply voltage.

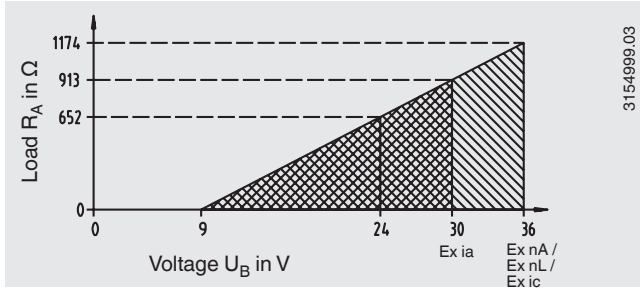

Designation of Terminal Connections

Head mounting version

Thermocouple

CJC with external Pt100/ Ni100 ¹⁾ CJC internal

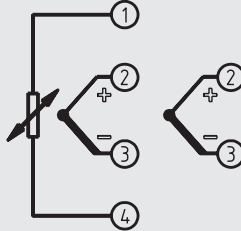

Resistance thermometer / resistance sensor

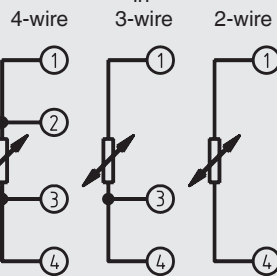

mV-sensor

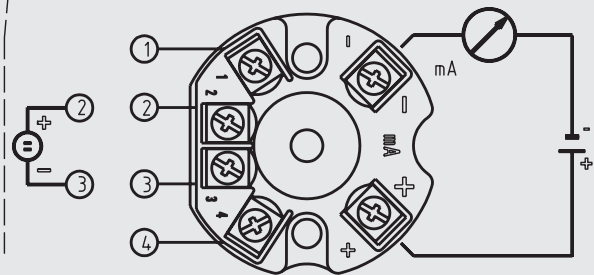

1) Connect sensor (Pt100 / Ni100) for external cold junction compensation between terminal 1 and 4.

3134032.02

Rail mounting version

4 ... 20 mA loop

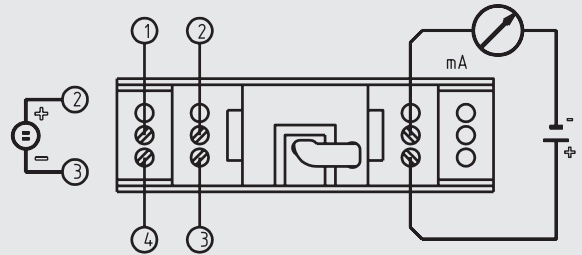

3135039.02

Dimensions in mm

Head mounting version

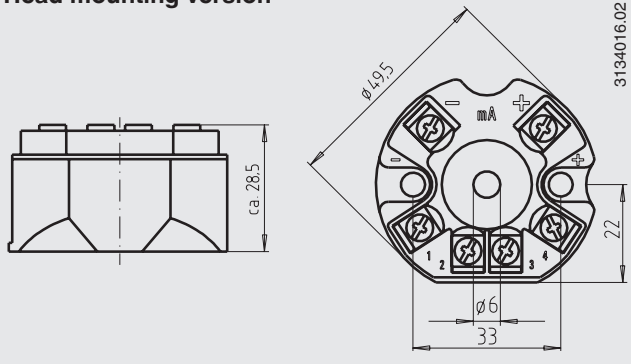

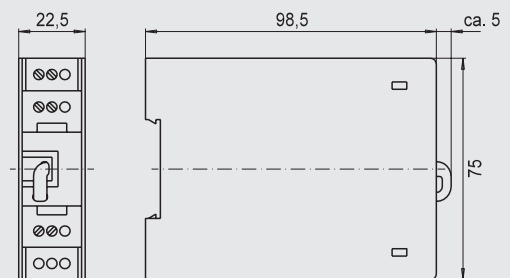

Rail mounting version



Accessories

WIKA configuration software WIKA_T12 (multi-lingual, online help): free-of-charge download via www.wika.de

Feldgehäuse, Adapter

Model	Design	Special features	Dimensions	Order No.
Field housing 	Plastic (ABS)	Field case, IP 65, for mounting of a head mounting transmitter, permissible ambient temperature range: -40 ... +80 °C 82 x 80 x 55 mm (W x L x H), with two cable glands M16 x 1.5	80 x 82 x 55 mm	3301732
Adapter 	Plastic / stainless steel	suitable for TS 35 per DIN EN 60715 (DIN EN 50022) or TS 32 per DIN EN 50035	60 x 20 x 41,6 mm	3593789
Adapter 	Steel tin galvanized	suitable for TS 35 per DIN EN 60715 (DIN EN 50022)	49 x 8 x 14 mm	3619851

Configuration set for T12

Model	Description	Order No.
Configuration set 	<ul style="list-style-type: none"> ■ Programming Unit for the connection to a Windwos PC, incl. 9 V battery ■ Connection cable, RS232-C (9-pin sub -D - plug) ■ Two additional connection cables Programming Unit ↔ Transmitter T12 	3634842

Screenshot configuration software

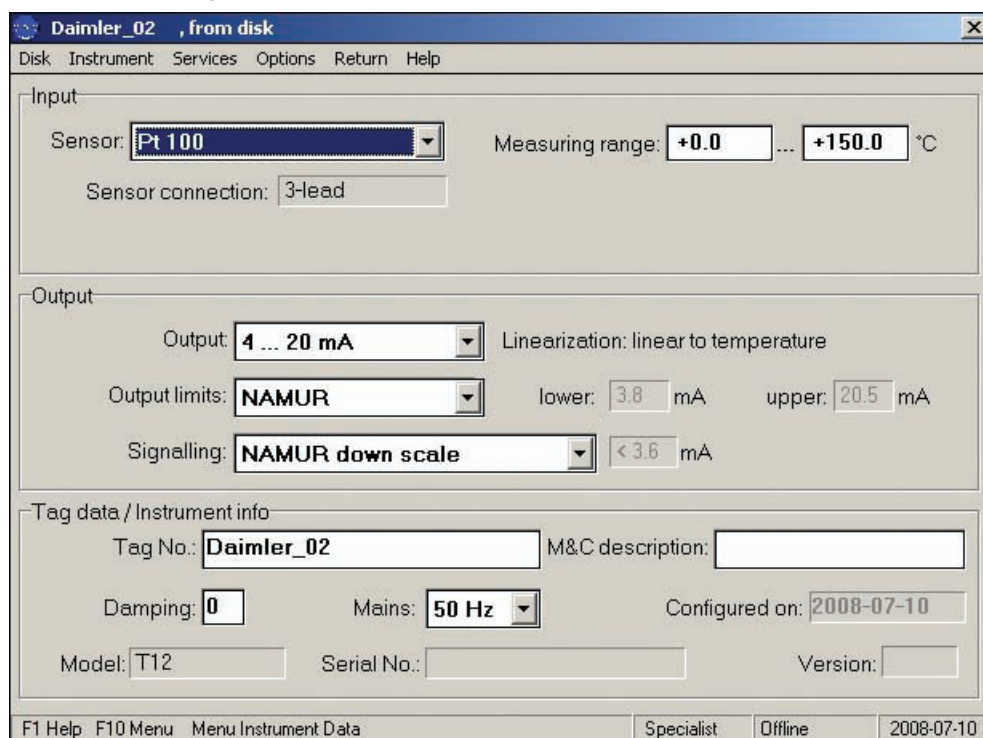

The screenshot shows the configuration software interface for a Wika transmitter. The window title is "Daimler_02 , from disk". The menu bar includes "Disk", "Instrument", "Services", "Options", "Return", and "Help".

Input section:

- Sensor: Pt 100 (dropdown menu)
- Measuring range: +0.0 ... +150.0 °C
- Sensor connection: 3-lead

Output section:

- Output: 4 ... 20 mA (dropdown menu)
- Linearization: linear to temperature
- Output limits: NAMUR (dropdown menu)
- lower: 3.8 mA, upper: 20.5 mA
- Signalling: NAMUR down scale (dropdown menu)
- < 3.6 mA

Tag data / Instrument info section:

- Tag No.: Daimler_02
- M&C description: (empty text box)
- Damping: 0
- Mains: 50 Hz (dropdown menu)
- Configured on: 2008-07-10
- Model: T12
- Serial No.: (empty text box)
- Version: (empty text box)

The status bar at the bottom shows: "F1 Help F10 Menu Menu Instrument Data Specialist Offline 2008-07-10".

Connection of Programming Unit PU348

T12.10 head mounting version

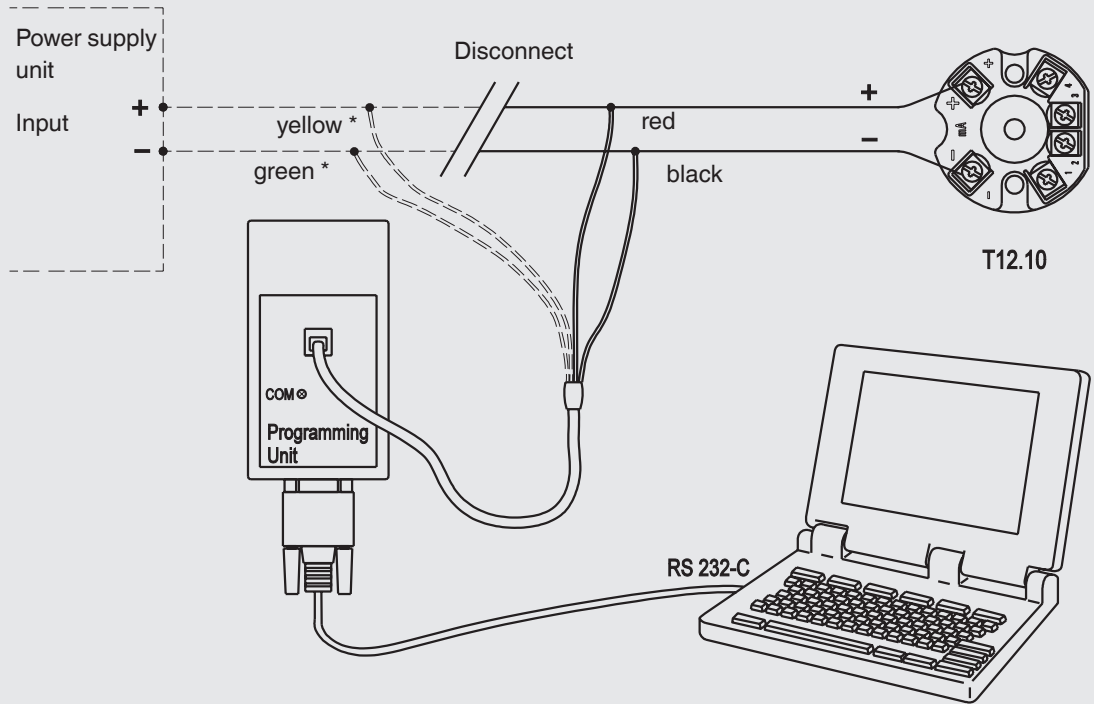

3214338.02

T12.30 Schienenversion

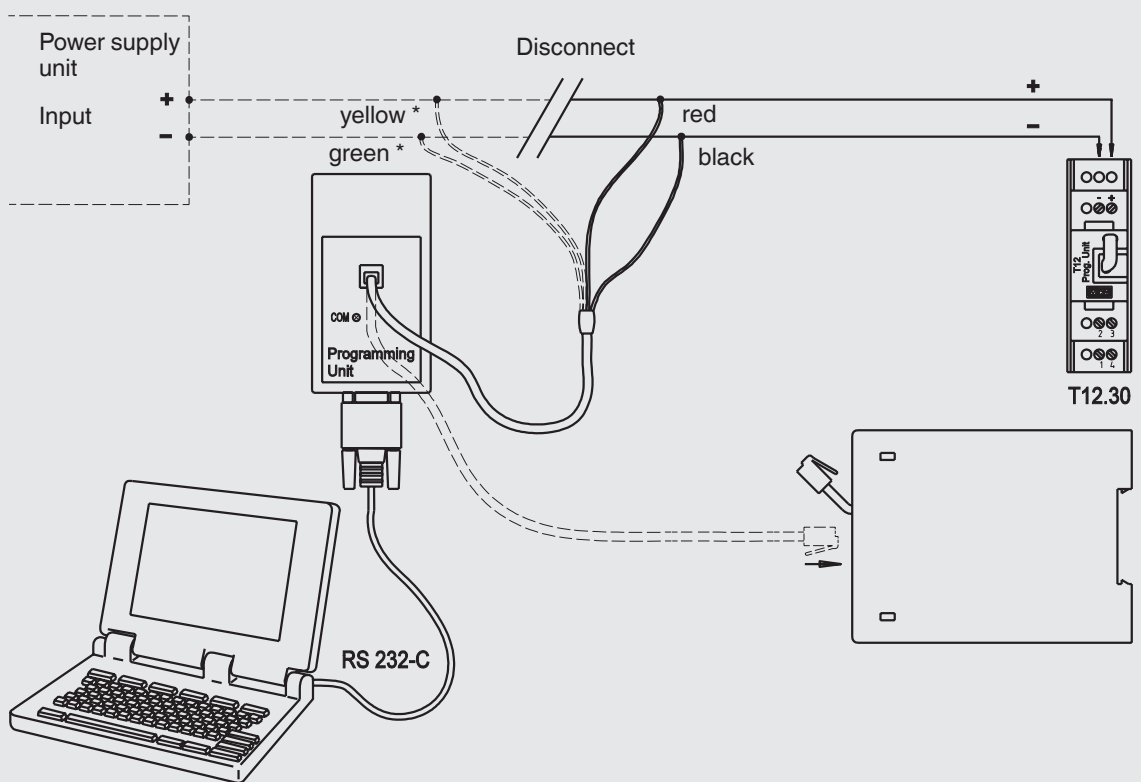

3214346.02

Yellow* and green* are connected only if configuration of the transmitter is to be made when the transmitter is on-line. When configuring in the workshop, an external power supply is not required as the Programming Unit provides the power.

The specifications given in this document represent the state of engineering at the time of publishing.
We reserve the right to make modifications to the specifications and materials.



WIKA Alexander Wiegand SE & Co. KG
Alexander-Wiegand-Straße 30
63911 Klingenberg/Germany
Tel. (+49) 9372/132-0
Fax (+49) 9372/132-406
E-mail info@wika.de
www.wika.de